

R I V E T

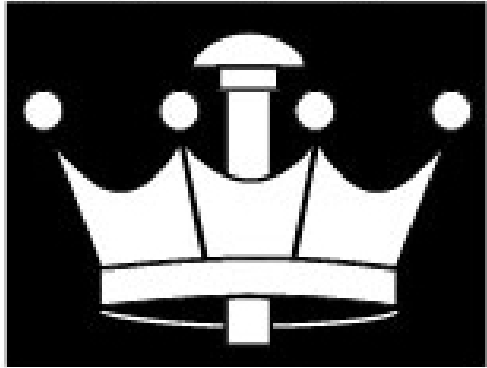

K I N G®

FOR PARTS, SALES, AND SERVICE IN THE U.S.A. CALL:

**Industrial
Rivet &
Fastener Co.**



1-800-BUY-RIVET
Fax: 201-750-1050
Email: info@rivet.com
Website: www.rivet.com

200 Paris Avenue
Northvale, New Jersey
07647

RK-50SP-B



**Industrial
Rivet &
Fastener Co.**



SPIN-PULL THREADED INSERT TOOL

Operating Instructions

INCHES/METRIC

**Read All Safety Rules and Instructions Carefully
Save this manual for Future Reference**

IMPORTANT SAFETY WARNINGS:

THE SAFETY WARNINGS BELOW CANNOT COVER ALL POSSIBLE SITUATIONS THAT MAY OCCUR. THESE BASIC SAFETY PRECAUTIONS SHOULD ALWAYS BE FOLLOWED TO PROTECT AGAINST PERSONAL INJURY TO THE OPERATOR OR OTHER PERSONNEL IN THE AREA, AS WELL AS DAMAGE TO THE EQUIPMENT. READ AND UNDERSTAND THESE WARNINGS BEFORE USING EQUIPMENT.

Keep tool away from children, and DO NOT allow children near work area. Do not allow children or untrained personnel to handle this tool.

DO NOT operate this tool while tired, or under the influence of drugs, alcohol, or medication that makes you drowsy.

Never point the tool at yourself or others - always assume that the tool is loaded and proceed with caution.

Wear safety glasses and ear protection. The operator and all personnel in the work area must wear safety glasses that protect the front and side, to avoid eye injury. Ear plugs should be worn to avoid hearing damage.



If operator will be working in a situation where overhead work will be done (i.e. on a ladder, stairs, or scaffolding) a hard hat must be worn.

ANSI Z87.1

Never wear loose clothing or jewelry because it can get caught in the moving parts of this tool. Make sure long hair is covered, to avoid getting it caught in tool.

Keep the tool pointed away from yourself and others at all times. Keep hands and all body parts away from rear area of nailer (near air hose) to guard against injury.

Keep proper balance and footing at all times - do not over-reach.

Never use oxygen, bottled gas or any type of combustible fuel as a power source - it can cause an explosion and serious injury.

Use an air hose that will withstand at least 150 psi, OR 150% of the maximum pressure of the compressor.

Never connect this tool to compressed air if the pressure could exceed 150 psi, as the nailer could burst. Use only clean, dry, regulated compressed air, with pressure not exceeding 120 psi.

Do not use a non-relieving coupler with this tool- if used, the tool could remain charged with air after disconnecting, and would still be able to work even after being disconnected. The tool and air hose must have a coupling so that all pressure is removed from the tool when the coupling is disconnected.

Do not use an air hose that is too long - operator can trip over it. Make sure all connections are tight.

(WARNINGS continued next page)

NO.	PART NO	DESCRIPTION	QTY
1	RK50SP-1-832	mandrel 8-32UNC	1
1	RK50SP-1-1024	mandrel 10-24UNC	1
1	RK50SP-1-1032	mandrel 10-32UNC	1
1	RK50SP-1-1420	mandrel 1/4-20UNC	1
1	RK50SP-1-1428	mandrel 1/4-28UNF	1
1	RK50SP-1-51618	mandrel 5/16-18UNC	1
1	RK50SP-1-51624	mandrel 5/16-24UNF	1
1	RK50SP-1-3816	mandrel 3/8-16UNC	1
1	RK50SP-1-3824	mandrel 3/8-24UNF	1
1	RK50SP-1-1213	mandrel 1/2-13UNC	1
1	RK50SP-1-1220	mandrel 1/2-20UNC	1
1	RK50SP-1-M407	mandrel M4x0.7	1
1	RK50SP-1-M508	mandrel M5x0.8	1
1	RK50SP-1-M61	mandrel M6x1.0	1
1	RK50SP-1-M71	mandrel M7x1.0	1
1	RK50SP-1-M81	mandrel M8x1.0	1
1	RK50SP-1-M8125	mandrel M8x1.25	1
1	RK50SP-1-M101	mandrel M10x1.0	1
1	RK50SP-1-M10125	mandrel M10x1.25	1
1	RK50SP-1-M1015	mandrel M10x1.50	1
1	RK50SP-1-M1215	mandrel M12x1.50	1
2	RK50SP-2-832	nose piece 8-32UNC	1
2	RK50SP-2-1024	nose piece 10-24UNC	1
2	RK50SP-2-1032	nose piece 10-32UNF	1
2	RK50SP-2-1420	nose piece 1/4-20UNC	1
2	RK50SP-2-1428	nose piece 1/4-28UNF	1
2	RK50SP-2-51618	nose piece 5/16-18UNC	1
2	RK50SP-2-51624	nose piece 5/16-24UNF	1
2	RK50SP-2-3816	nose piece 3/8-16UNC	1
2	RK50SP-2-3824	nose piece 3/8-24UNF	1
2	RK50SP-2-1213	nose piece 1/2-13UNC	1
2	RK50SP-2-1220	nose piece 1/2-20UNC	1
2	RK50SP-2-M407	nose piece M4x0.7	1
2	RK50SP-2-M508	nose piece M5x0.8	1
2	RK50SP-2-M61	nose piece M6x1.0	1
2	RK50SP-2-M71	nose piece M7x1.0	1
2	RK50SP-2-M81	nose piece M8x1.0	1
2	RK50SP-2-M8125	nose piece M8x1.25	1
2	RK50SP-2-M101	nose piece M10x1.0	1
2	RK50SP-2-M10125	nose piece M10x1.25	1
2	RK50SP-2-M1015	nose piece M10x1.5	1
2	RK50SP-2-M1215	nose piece M12x1.25	1
2	RK50SP-2-M125	nose piece M12x1.5	1
2	RK50SP-2-M12175	nose piece M12x1.75	1
3	RK50SP-3-1	set nut (M4-M6)	1
3	RK50SP-3-2	set nut (M8-M12)	1

NO.	PART NO	DESCRIPTION	QTY
4-6	RK50SP-4-6	front sleeve complete	1
7A	RK50SP-7A	security part	1
8A	RK50SP-8A	spring holder	1
9A	RK50SP-9A	spring	1
10	RK50SP-10	pin cylindrical	1
10A	RK50SP-10A	pin cylindrical	2
11A	RK50SP-11A	lock nut	1
14A	RK50SP-14A	hydraulic plunger complete	1
17	RK50SP-17	buffer ring	1
18	RK50SP-18	cap screw	1
20	RK50SP-20	hanger	1
21A	RK50SP-21A	hydraulic body	1
23	RK50SP-23	guide ring	1
26	RK50SP-26	sleeve	1
27	RK50SP-27	protective sleeve	1
28	RK50SP-28	pin cylindrical	1
29	RK50SP-29	compression spring	1
30	RK50SP-30	compression spring	1
31	RK50SP-31	rear screwed joint	1
32	RK50SP-32	ring for compression spring	1
33	RK50SP-33	muffler	1
34	RK50SP-34	push button	1
36A	RK50SP-36A	OIL TUBE PISTON	1
38A	RK50SP-38A	pneumatic plunger complete	1
38-1	RK50SP-38-1	air cylinder piston	1
38-2	RK50SP-38-2	piston rod	1
38-3	RK50SP-38-3	cap screw	1
38-4	RK50SP-38-4	piston ring	1
39	RK50SP-39	pneumatic cylinder	1

NO.	PART NO	DESCRIPTION	QTY
40	RK50SP-40	cover ring	1
43	RK50SP-43	coupling for pressure gauge	1
45	RK50SP-45	pressure gauge	1
46	RK50SP-46	oil level indicator	1
48	RK50SP-48	pressure relief valve	1
49	RK50SP-49	pressure regulation valve	1
51	RK50SP-51	retaining ring	1
52	RK50SP-52	pression regulation screw	1
53	RK50SP-53	covering	1
54	RK50SP-54	retaining ring	1
55	RK50SP-55	bottom ring	1
56	RK50SP-56	union coupling	1
57	RK50SP-57	connecting bolt	2
58	RK50SP-58	copper washer for connecting bolt	2
59	RK50SP-59	cap nut for connecting bolt	2
60	RK50SP-60	bolt below valve pin	1
62	RK50SP-62	sleeve for needle valve	1
63A	RK50SP-63A	SCREW M4	1
65A	RK50SP-65A	adjusting ring	1
67	RK50SP-67	valve pin	1
68	RK50SP-68	pin cylindrical	1
69	RK50SP-69	eccentric trigger	1
70	RK50SP-70	trigger	1
72	RK50SP-72	needle valve for time of return	1
73	RK50SP-73	cap screw	1
76	RK50SP-76	plastic board	1
77	RK50SP-77	compression spring	1
78	RK50SP-78	tapping screw	4
79	RK50SP-79	adjusting pusher	1

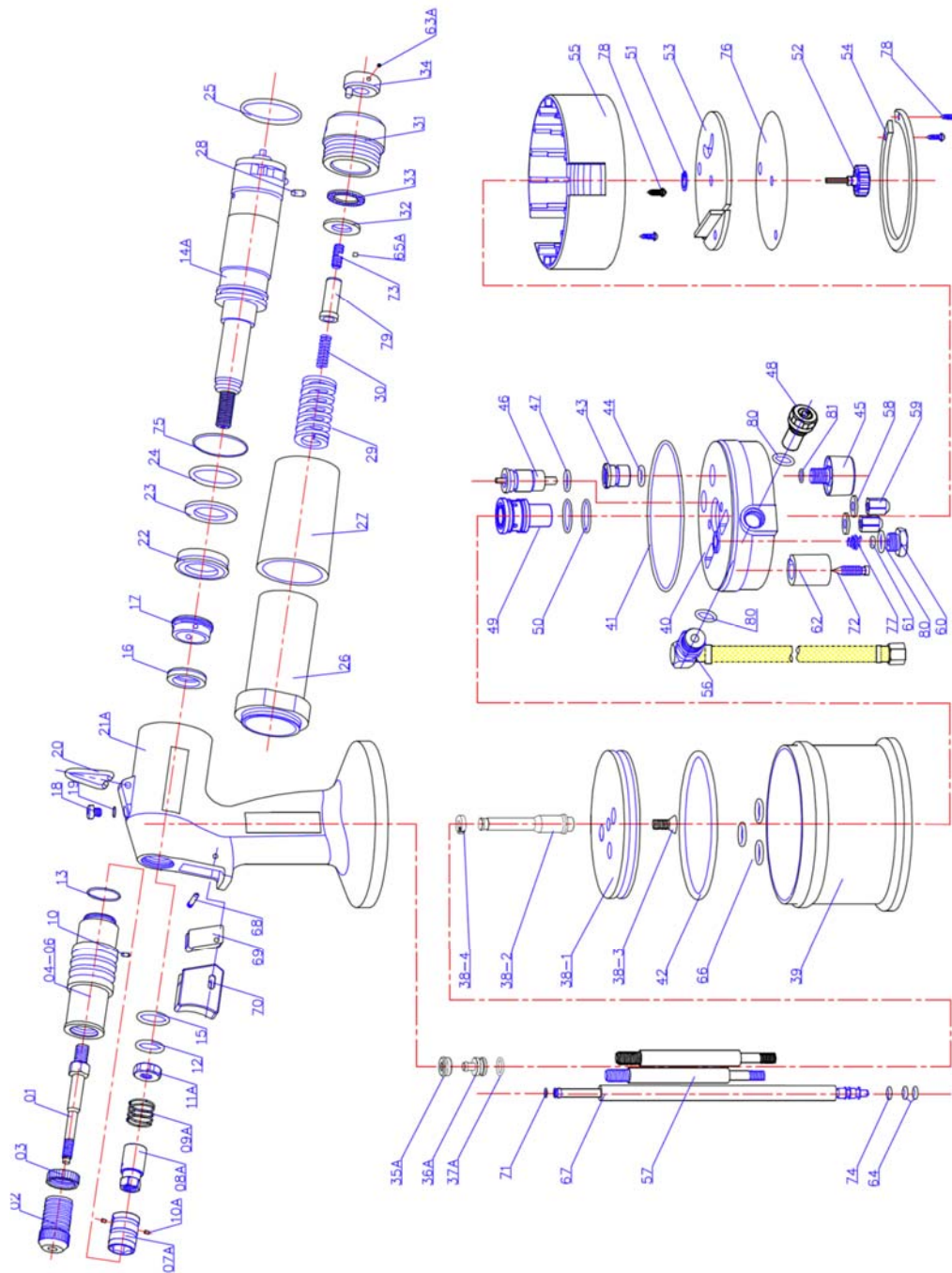

IMPORTANT SAFETY WARNINGS: continued

Disconnect air hose from tool:
 -before performing maintenance.
 -when clearing a jam.
 -when tool is not in use.
 -when moving it to another location.
 -When handing tool to another person.

Carry tool by the handle only, not by the air hose.

Never use the tool if it is leaking air, the contact safety mechanism is not working, tool has missing or damaged parts, or requires repair. Make sure all screws and caps are securely tightened.

Inspect the tool before each use to insure all parts are operating properly. Lock the tool in a clean, dry storage area between uses.

Unauthorized parts or fasteners can lead to malfunction and serious injury. Only personnel trained or the distributor shall repair the tool. Don't modify this tool in any way.

Never use this tool in sites containing lacquer, paint, benzene, thinner, gasoline, gases, adhesive agents, and other materials which are combustible or explosive.

Do not store the tool in a cold weather environment. Keep the tool in a warm area until the start of work. If it is in a cold area, bring it in a warm area and allow it to warm up before use.

Manufacturer assumes no responsibility for consequential or indirect damages from the use of this product.

Save this manual and have it available for tool operators reference!

California Proposition 65

You can create dust when you cut, sand, drill or grind materials such as: wood, paint, metal, concrete, cement, or other masonry. This dust often contains chemicals known to cause cancer, birth defects or other reproductive harm. Wear protective gear.

APPLICATIONS

Including but not limited to installing blind rivet nuts/bolts in various materials.

FEATURES

- Automatic right and left hand running
- Fully automatic air pressure regulation system
- Oil-level indicator
- Quick interchange setting system
- Carrying Case with maintenance tools enclosed

AIR SUPPLY



NEVER use oxygen or other bottled gases. Explosion may occur.

This tool is designed to operate on clean, dry, regulated compressed air, between 75 and 100 psi. It is preferable to include an air filter, pressure regulator, and automatic oiler within 15 feet of the tool, if possible.

An air filter is needed to remove contaminants and moisture that are contained in compressed air; filtering will significantly prolong the life of the tool. If an automatic oiler is not installed, place 2 to 3 drops of oil into the tool's air inlet twice a day. Do not install a quick coupler directly into the tool. Higher pressure drastically reduces tool life.

The tool comes factory-equipped with a male quick connector. The tool must always be connected to the air supply with a coupling that removes all pressure when it is disconnected.

NOTE: all components used with this tool (air hose, connectors, regulators, filters, etc) must be rated at 120 psi, OR 120% of the maximum compressor potential, whichever is higher. Do not connect this tool to a system with maximum potential air pressure greater than 200 psi.

AIR CONNECTION SET UP

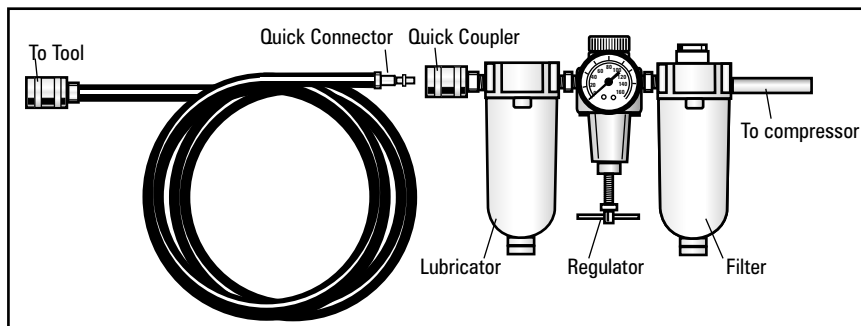

DESCRIPTION OF THE PRESSURE REGULATION SYSTEM

The following can be found at the bottom

- Pressure relief valve (A) acting as safety valve to prevent overloading of the tool. The valve opens if the compressed air pressure exceeds 7 bar.
- Green indicator shows air pressure (B). It is possible to fit the supply hose to the other side (at the location of the pressure relief valve). The pressure relief valve is then relocated to the supply hose connection.
- Set screw for pressure adjustment (C).
- Pressure indicator (D).
- Oil level indicator (E).
- Needle valve for time of return (F).

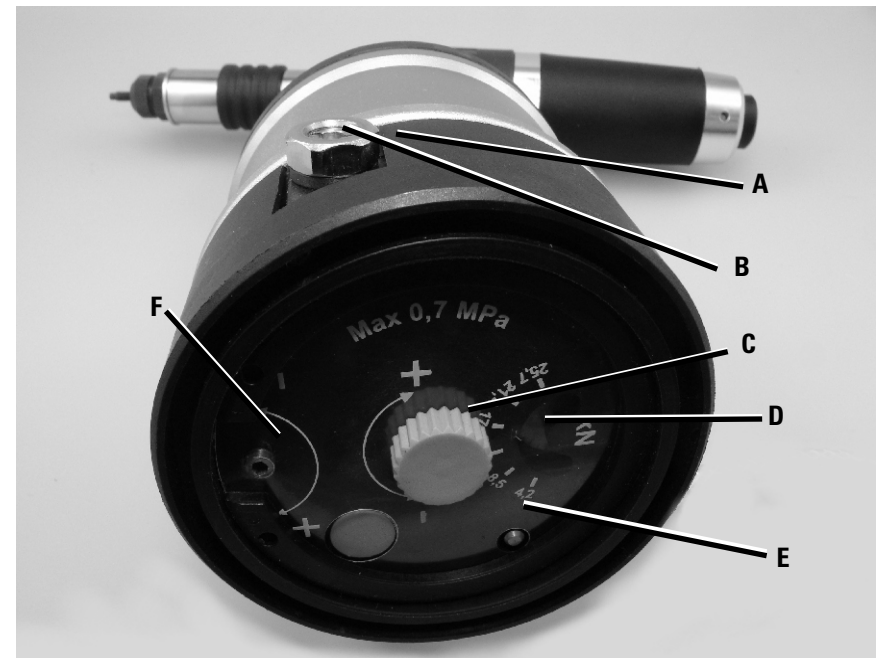

OPERATION

THREADED MANDREL, ADAPTER, AND NOSE REPLACEMENT

You have the correct mandrel/adapter (A) if its threads correspond to that of the nut/bolt.
You have the correct nose piece (B) if it fits tightly around the thread of the mandrel or bolt.

Proceed as follows to replace a mandrel with nose piece:

- 1) Disconnect the tool from the compressed air supply.

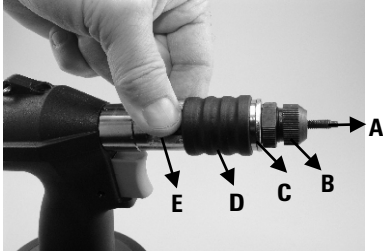

- 2) Unscrew the lock nut (C) from the nosepiece (B).
- 3) Screw the nosepiece with the lock nut right out of the nose piece holder. The lock nut remains on the nose piece.
- 4) Unlock and push the protective sleeve (D) forward.
- 5) Push the spring loaded security part (E) backwards to release the mandrel.
- 6) In this position, release the mandrel by turning it counter-clockwise.
- 7) In this position, screw the selected mandrel until it stops by turning clockwise. You have the correct mandrel if its thread corresponds to that of the nut/bolt.
- 8) Release the security part (E) and ensure that the retaining device covers the hexagon of the mandrel well.
- 9) Push the protective sleeve backwards and secure it.
- 10) Screw the relevant nose piece with the lock nut into the nose piece holder. You have the correct nose piece if it fits tightly around the thread of the mandrel.
- 11) Adjust the nose piece (B):

For nuts:

Screw a nut up to its collar against the nose piece on the mandrel and adjust the nose piece. The nose piece is set properly if the thread of the mandrel protrudes one thread from the back of the nut screwed on the mandrel. Retain the nose piece and lock it with the lock nut.

For bolts:

Connect the tool to the compressed air supply.
Screw the nosepiece on the adapter. The air motor should not start running, (if it does, unscrew the nose piece until it stops). Now unscrew the nose piece by another 1 ½ turns. Disconnect the tool from the compressed air supply. Retain the nose piece and lock it with the lock nut.

- 12) Replacement of the mandrel with nose piece is now completed. Then the riveter must be set the correct pressure belonging to the nut/bolt and the clamping capacity.

OPERATION

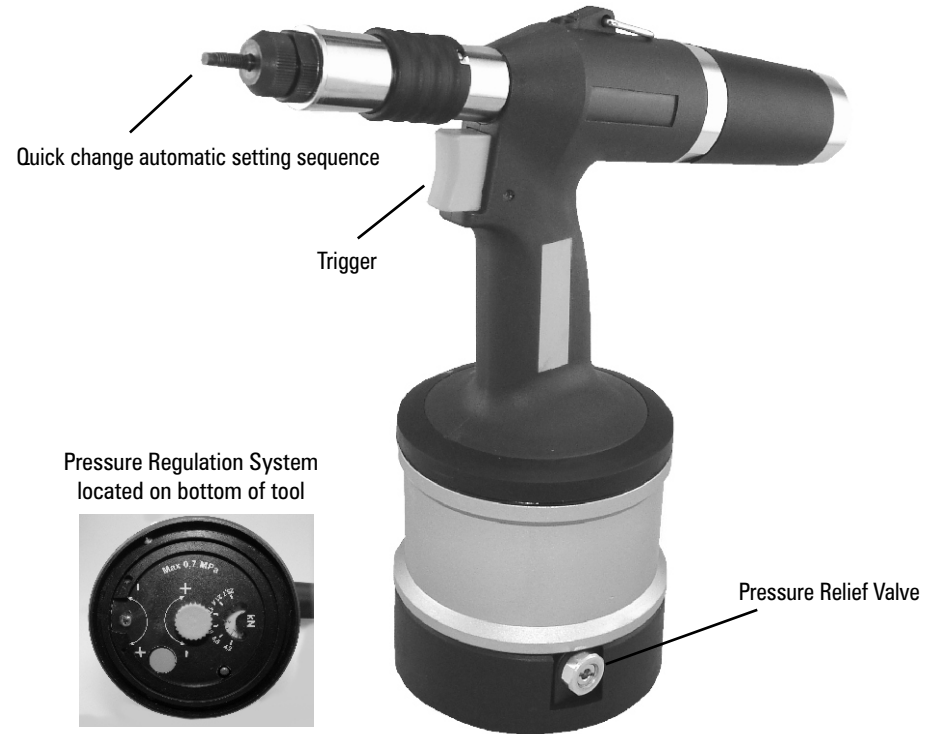

SPECIFICATIONS

Overall Dimensions	12.0" x 11.0"
Stroke	.276"
Air Pressure	75-100 PSI
Motor Speed (on/off)	2000rpm
Pull Force	6,565 lbs. @ 72.5 PSI
Weight of Tool:	5.5 lbs.

Threaded Insert Selection Included:

Sets: 8-32,10-24,10-32,1/4-20,
5/16-18, 3/8-16

Threaded Inserts also sold separately:

Sets: 1/4-28, 5/16-24, 3/8-24,1/2-13, 1/2-20,
M5, M6, M8, M10

Dimensions

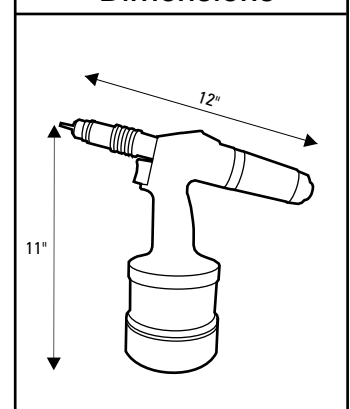

Mode of Operation

Fit the correct threaded mandrel and nose piece to the tool. Set the nose piece. The nose piece is correctly set if the mandrel protrudes by one thread from the back of the nut. Connect the tool to the compressed air supply using the quick-action coupling. Ensure that the filter/separator unit is set at an operating pressure between 75-100 PSI. Set the correct pressure. The pressure can be adjusted by the screw set at the bottom of the tool (Fig. 2).

The tool is provided with a fully automatic air motor for screwing nuts/bolts on and off.

First screw the nut/bolt one turn on the mandrel. By pushing the nut/bolt straight against the Mandrel (Fig. 1), the mandrel will start to rotate in clockwise direction to screw the nut/bolt on. Ensure that the collar of the nut/bolt is facing towards the nose piece. The rotation stops automatically when the nut/bolt hits the nose piece. Place the nut/bolt in the material. Be sure to use the correct hole size. **Please Note:** the hole size in the material is 0.1 mm larger than the outside diameter of the nut/bolt.

-The nut/bolt is installed by operating the trigger. The mandrel automatically rotates counter-clockwise and comes off the nut/bolt when the trigger is released. The next nut/bolt can now be placed on the tool.

-The time of counter-clockwise rotation can be set by turning the adjustment screw (Fig. 2). By turning the screw clockwise, the time of rotation is enlarged. By pushing the push button, extra counter-clockwise rotation is possible.



Figure 1

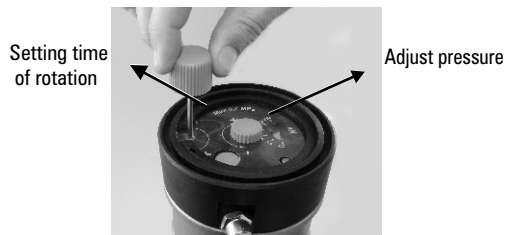

Figure 2

MAINTENANCE

Lubrication

It is important that the tool be properly lubricated. There may be insufficient oil if the stroke of the tool is too small for proper installation of nuts/bolts. Without proper lubrication the tool will not work properly and parts will wear prematurely. First check whether the stroke setting is correct. Check the oil level indicator to see whether loss of oil has occurred. The tool has lost oil if the oil level indicator pin no longer protrudes.

Adding oil to your tool:

- 1) Keep the tool upright during all operations. Disconnect the tool from the air supply.
- 2) Unscrew the cap screw from the body using the allen wrench included. Check whether the O-ring remains in the hole.
- 3) Fill the syringe (included) with hydraulic oil.
- 4) Screw the filled syringe up to the O-ring in the hole. Then slowly inject the oil into the tool (Make sure no air is injected). Adequate oil has been added as soon as resistance is sensed. The excess oil will flow back when the syringe is release if more oil is added than necessary.
- 5) Unscrew and remove the syringe from the body. Check whether the O-ring remains in the hole.
- 6) Screw the cap screw into the hole using the allen wrench.
- 7) Wipe off any excess oil.

Adjusting Air Pressure

Do not exceed 120 PSI. Adjust the air pressure at the recommended operating pressure of 75 to 100 PSI. The pressure can be adjusted by the set screw (Fig. 3) at the bottom of the tool. The tool is set at its minimum pressure when it leaves the factory.

-Turn the set screw clockwise to increase the pressure. Turn the set screw counter-clockwise to reduce the pressure. When reducing the pressure, always operate the trigger to let the pressure release.

-The set pressure can be read from the pressure indication (Fig. 3).

For adjusting the pressure belonging to the nut/bolt:

-First adjust to the minimum pressure and then slowly increase.

-Place a nut/bolt on the mandrel.

-Operate the trigger and increase the pressure by turning the set screw clockwise until the nut/bolt deforms.

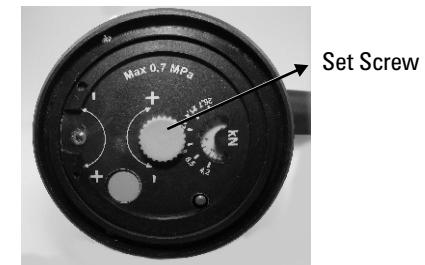

Figure 3

If problems should occur with the setting of the pressure, disconnect the tool from the compressed air supply to release the tool from the pressure.

Testing the air pressure

Check the pressure setting in a field test is recommended. A number of blind riveting nuts or bolts are installed into the original material or a test plate for its purpose. This test plate must have the same thickness and hole diameter: also ensure that the test plate and the work piece are made of the same material.